

LEGO

7-12

**STAR
WARS**



4176940

7103

JEDI™ DUEL

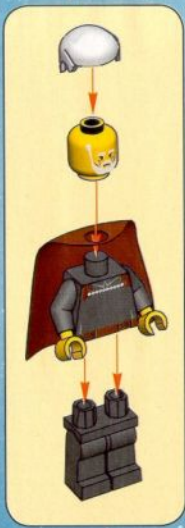

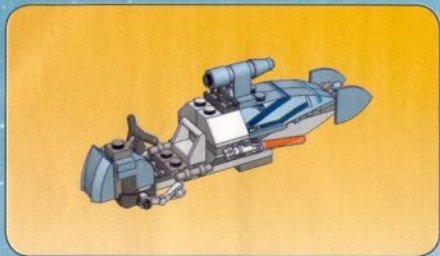

1

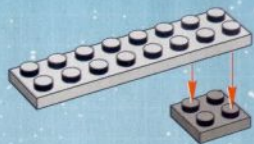

2



3

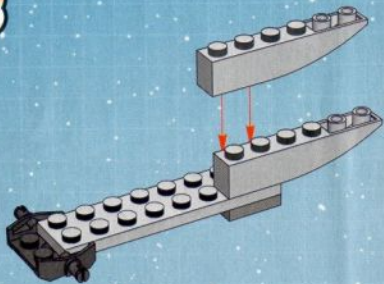

4

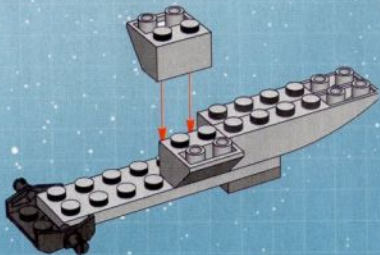

5

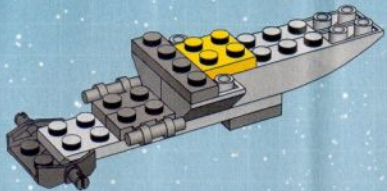

6

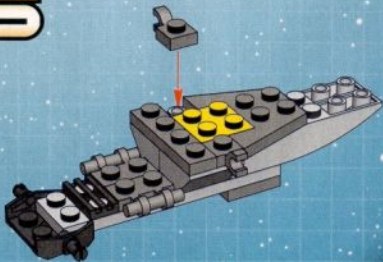

7

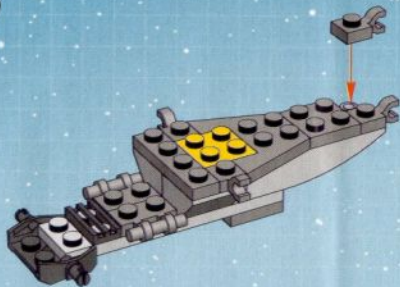

8

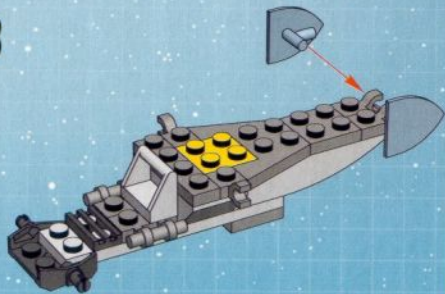

9

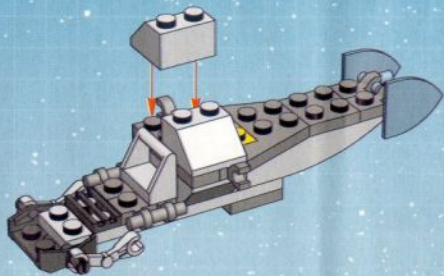

10

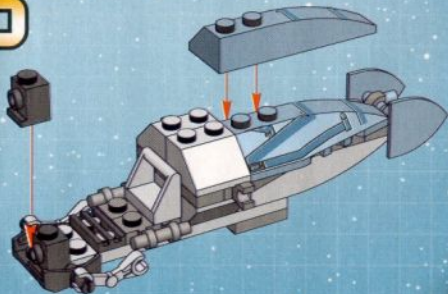

11

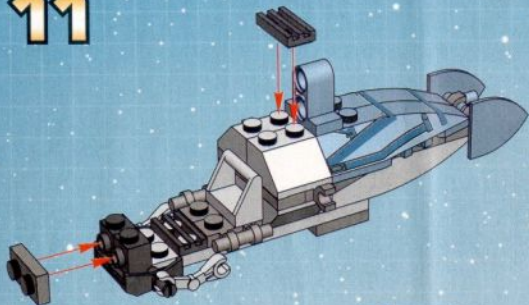

12

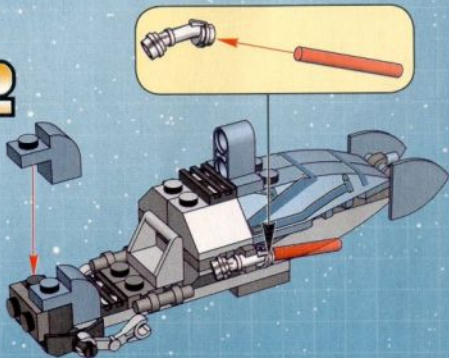

13

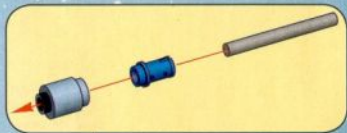
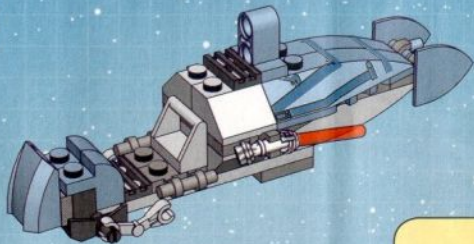

14

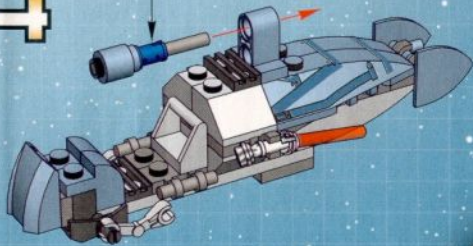

15



16



17



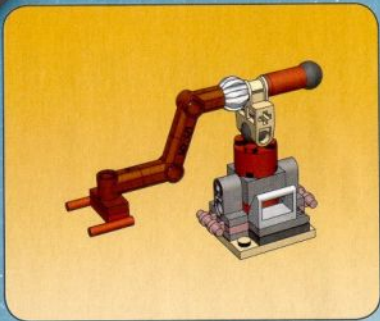

1

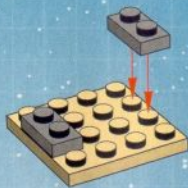

2

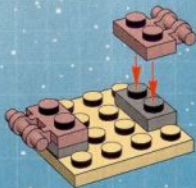

3



4

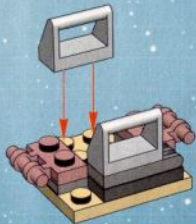

5

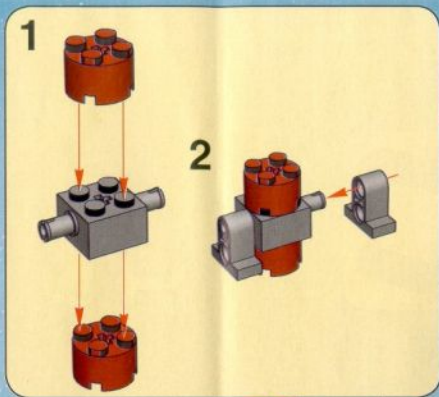

6

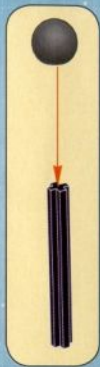

7



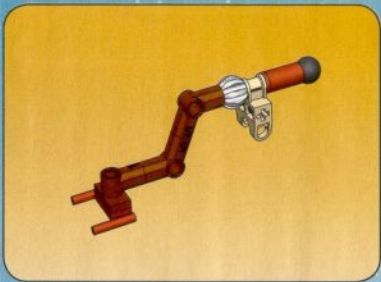

1



2

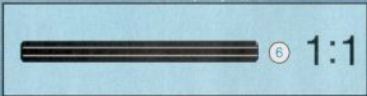

3

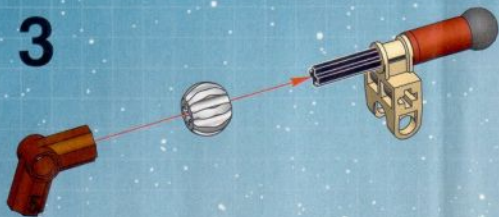

4



5

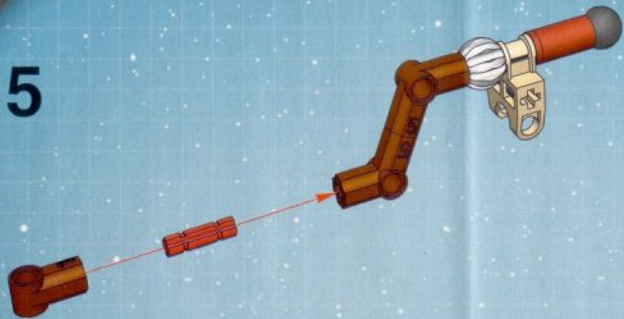

6

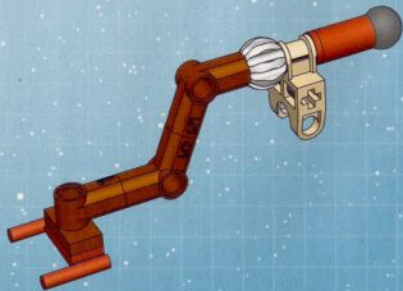
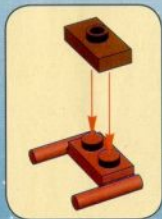

8



9





STAR WARS

ATTACK OF THE CLONES™



7133





7113

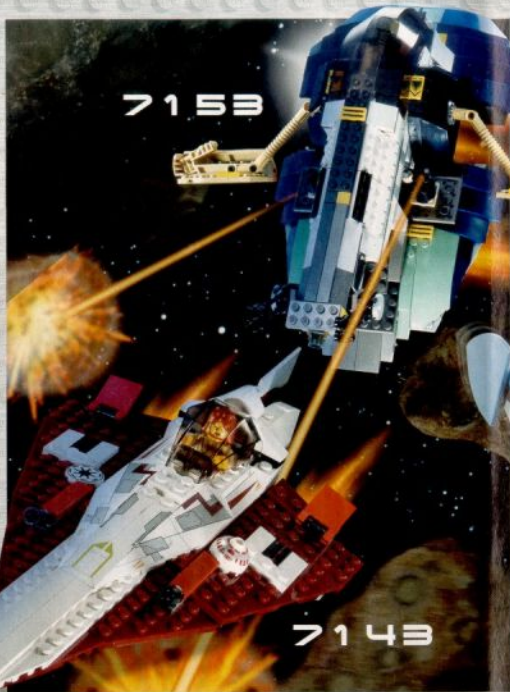



LEGO STAR WARS



7200

7201



STAR WARS
WWW.STARWARS.COM

www.LEGO.com/starwars

LEGO, the LEGO logo, the JUST IMAGINE logo and the Minifigure are trademarks of/ sont des marques de commerce de/ son marcas registradas de LEGO Group.

©2002 Lucasfilm Ltd. & TM/MC. All rights reserved. Used under authorization./Tous droits réservés. Utilisé sous autorisation./ Todos los derechos reservados. Usado bajo autorización.